

Please, read this manual
before use!

Instruction



Diesel generator

KS 6100HDE (KS 6102HDE)

KS 8100HDE (KS 8102HDE)

KS 8100HDE-1/3 ATSR (KS 8102HDE-1/3 ATSR)

KS 9100HDE-1/3 ATSR (KS 9102HDE-1/3 ATSR)

Diesel generator in soundproof housing

KS 8200HDES-1/3 ATSR

KS 9200HDES ATSR (KS 9202HDES ATSR)

KS 9200HDES-1/3 ATSR (KS 9202HDES-1/3 ATSR)

KS 9300DE ATSR (KS 9302DE ATSR)

KS 9300DE-1/3 ATSR (KS 9302DE-1/3 ATSR)

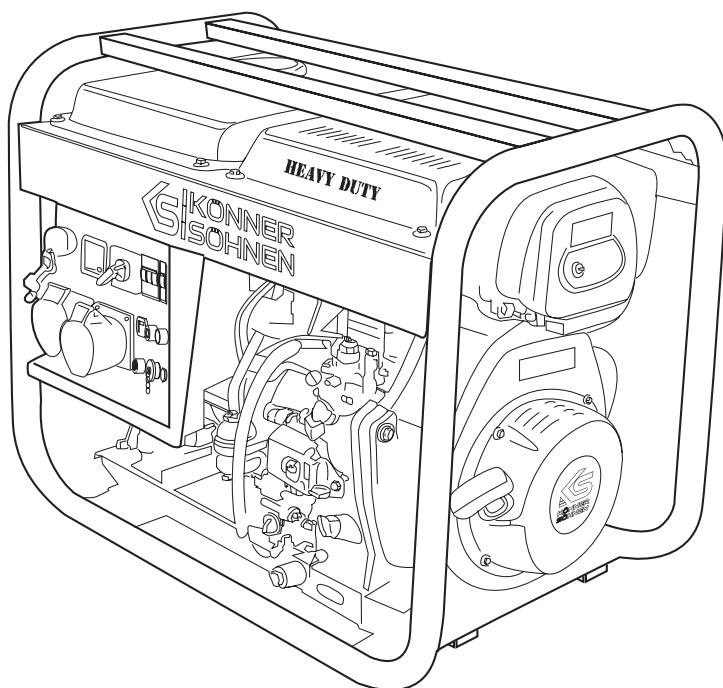



1. Introduction	2
2. Safety information	2
3. Safety symbols. Description of safety symbols when operating the generator	4
4. Main overview	5
5. Models description	6
6. Terms of use	10
7. Before starting	10
8. Control panel	11
9. Starting to work	11
10. Technical maintenance works	14
11. Recommended oils	15
12. Air filter maintenance	16
13. Fuel filter technical maintenance	16
14. Accumulator maintenance	17
15. Generators` storage	17
16. Battery and generator disposal	17
17. Possible failures and solutions	18
18. Average power usage	19
19. Warranty terms and conditions	20

ABBREVIATIONS MEANING:



KS	Generator Könnert & Söhnen [®]
D	Diesel
E	Electric start
S	Soundproof housing
1/3	Three-phase generator
ATSR	ATS-input
H	HEAVY DUTY

Thank you for your purchase of **Könnner & Söhnen® HEAVY DUTY series** diesel generator. It is professional machinery with an increased service life and is therefore suitable for heavy-duty operation.

HEAVY DUTY series diesel generator engines have a service life of more than 3,000 operating hours subject to observance of the rules of generator operation and the maintenance schedule. This manual contains safe working recommendations, operation and adjustment description of these generators and maintenance instructions.

Manufacturer reserves the right to make alterations into the generators, which may not be reflected in this manual. Pictures and photos of the product may vary from its actual appearance.

At the end of this manual, You may find contact information which you are free to use in case of any issues occurrence. All data, specified in this operation manual is the most up to date for the moment of its publishing. The current list of service centers you can find at the website of official importer: www.koenner-soehnen.com



IMPORTANT!



Failure to follow the recommendations marked with this sign may lead to serious injury or death of the operator or third parties.



IMPORTANT!



Carefully read this manual before starting to work with the generator

WORKING AREA

- Please don't use the generator near flammable gases, liquids or dust. When using the generator exhaust system gets very hot. This may cause fire or explosion of these materials.
- Be sure to follow cleanliness and good lighting in the work area. Clutter and poor lighting may cause an injury.
- Do not let the presence of unauthorized persons, children or animals when working with generator. If necessary, make sure to fencing the working area.

ELECTRICAL SAFETY

- The generator produces electricity that may lead to an electric shock while neglecting compliance regulations.
- In the high humidity level conditions generator exploit is prohibited. Keep the generator in a dry place only.
- Avoid direct contact with grounded surfaces (pipes, radiators, etc.).
- Be careful when working with power cables. Immediately replace it in case of damage, as damaged wire increases the risk of electric shock.
- All connecting the generator to the network must be made by certified electrician in accordance with all electrical rules and regulations.
- Connect the generator to the protective ground before operation.
- Do not connect or disconnect a generator to electricity consumers, which are placed in water on a wet or damp soil.
- Do not touch parts of the generator under voltage.
- Connect the generator to those customers only which meet the electrical characteristics and the rated power of the generator.
- Store all electrical equipment dry and clean. Wires with damaged or spoiled insulation should be replaced. You should also replace worn, damaged or rusty contacts.

PERSONAL SAFETY

- Be careful. Do not operate the generator, if you are tired, under the influence of drugs or alcohol. Inattention may cause a serious injury.
- Avoid inadvertent start. Make sure to set the switch to Off when you turn off the generator.
- Make sure no outsider objects are on the generator when it is turned on.
- Always keep a stable position and balance when starting the generator.
- Do not overload the generator, use it only for the purpose.
- As exhaust gases contain poisonous carbon dioxide (CO₂) and carbon monoxide (CO) gases which are dangerous for life, it is strictly forbidden to install the generator in residential buildings, premises connected to residential buildings by a common ventilation system, other rooms from which exhaust gases may enter living premises.

OPERATING AND MAINTAINING THE GENERATOR

- Before you start checks before operating, make sure that the generator is on a flat level surface and the engine switch is set to OFF.
- Check the connection of moving parts, no damaged parts that affect the operation of the generator. If the generator is damaged, remove them before using.
- For repair and maintenance use only recommended oil fuel. Using other lubricants, spare parts and consumables deprives you of warranty apparatus.
- Servicing the generator should be carried out only by qualified personnel. The current list of service centers you can find at the website of official importer: **www.koener-soehnen.com**
- Keep the generator dry, well ventilated place if you are not using it.

**ATTENTION - DANGER!**

The generator runs on automotive diesel fuel and conform to European quality standards not lower than Euro 5 emission standard. The generator runs on automotive diesel fuel. Do not use gasoline, kerosene, fuel oil as fuel. Diesel fuel type should correspond the operating season.

The use of low-grade fuel can lead to a degradation of the manufacturer's declared specifications or to engine failure. Do not add any chemical additives to diesel fuel and do not mix diesel fuel with used engine oil or fuel oil.

Diesel fuel characteristics	Region of use
EN590:96	European Union
B5 2869-A1 or A2	Great Britain

Keep the fuel tank and refueling accessories clean and neat and ensure that no foreign objects / debris get into the fuel tank when refueling the generator. Sulfur content should not exceed 0.5% (less than 0.05% is recommended). Sediment and water content in fuel should not exceed 0.05%. A cetane number of at least 45 must be ensured. For example, biodiesel fuel which is known under the B5 brand, is permitted. This type fuel should contain no more than 5% of fatty acid methyl esters (FAME) and 95% of mineral diesel fuel. Read more about the requirements for biodiesel in the full web version: **koener-soehnen.com/manuals**

**ATTENTION - DANGER!**

To prevent electric shock and avoid damage to your electric devices and generator, simultaneous switching on of three and one phase circuit breaker is prohibited!

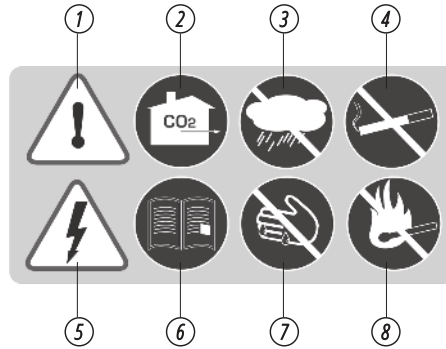

1. Be careful when operating the device! Observe the safety instructions in this manual.
2. Operate the generator only in well-ventilated indoor spaces or outdoors. Exhaust gases contain CO₂, whose vapors are life threatening.
3. Do not operate or store the device in highhumidity environments.
4. Do not smoke while operating the generator!
5. The device generates electricity. Observe safety precautions to avoid electric shock.
6. Read this owner's manual carefully before operating the device.
7. Do not touch the generator with wet or dirty hands.
8. Observe fire safety regulations, do not operate the generator near open flame.

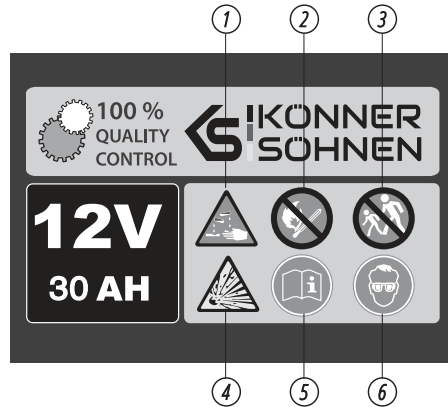

1. Wear protective rubber gloves when handling the battery. The battery contains a dangerous acid electrolyte. If electrolyte comes into contact with skin or face, rinse immediately with plenty of water and seek medical advice.
2. Do not operate the generator near open flame.
3. Keep children away from the generator work area.
4. Note! The battery releases explosive hydrogen while charging!
5. Read this owner's manual carefully before operating the device.
6. Wear safety goggles when operating the battery.

Diesel generator

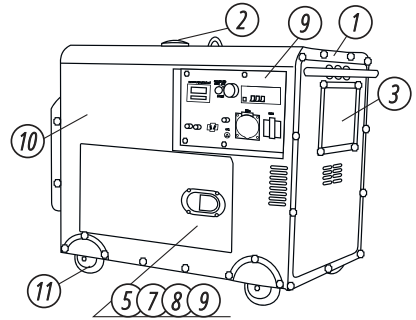
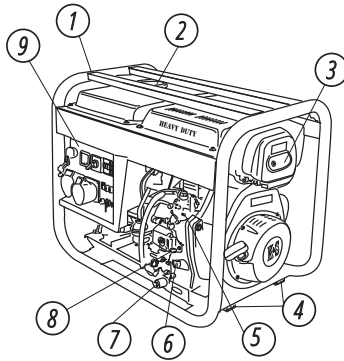

- 1. Reinforced steel frame
- 2. Fuel tank cap
- 3. Air filter
- 4. Antivibration supports
- 5. Fuel pump
- 6. Oil dipstick

- 7. The oil drain hole
- 8. Emergency switch engine
- 9. Maintenance panel
- 10. Soundproof housing
- 11. Wheels



IMPORTANT!



Manufacturer reserves the right to make changes and/or improvements in design, components set and technical attributes without notice and without incurring obligation. The pictures in this manual are schematic and may not match the parameters of original product.

SCOPE OF SUPPLY:

- 1. Generator
- 2. Packaging

- 3. Owner's manual
- 4. Accessories:

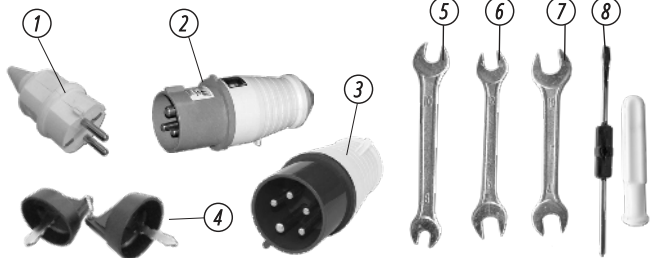

- 1. Portable plug 230V. 16A/ (2P+PE) - only for model of generators: KS 6100HDE (KS 6102HDE), KS 8100HDE (KS 8102HDE);
- 2. Portable plug 230V. 32A (2P+E);
- 3. Portable plug 400V. 16A (3P+E+N) - only for model of generators: KS 8100HDE-1/3 ATSR (KS 8102HDE-1/3 ATSR), KS 9100HDE-1/3 ATSR (KS 9102HDE-1/3 ATSR), KS 8200HDES-1/3 ATSR, KS 9200HDES-1/3 ATSR (KS 9202HDES-1/3 ATSR), KS 9300DE-1/3 ATSR (KS 9302DE-1/3 ATSR)

- 4. Start key
- 5. Open end wrench, 8x10 mm
- 6. Open end wrench, 12x14 mm
- 7. Open end wrench, 17x19 mm
- 8. Screwdriver 6.0 mm, PH2

Model	KS 6100HDE (EURO V) KS 6102HDE (EURO II)		KS 8100HDE (EURO V) KS 8102HDE (EURO II)	
Voltage, V	230		230	
Max Power, kW	5.5		6.5	
Nominal Power, kW	5.0		6.0	
Frequency, Hz	50		50	
Current max, A	23.91		28.26	
Outlets	1*16A, 1*32A		1*16A, 1*32A	
Fuel tank volume, l	11		11	
50% power working time, h*	8.5		6.9	
LED display	voltage, frequency, working hours			
Noise level Lpa (7m)/Lwa, dB	71/96		71/96	
Power output V/A	12/8.3		12/8.3	
Engine model	EURO II KS 440HD	EURO V KS 440HD-V	EURO II KS 480HD	EURO V KS 480HD-V
Engine type	diesel powered one-cylinder, four-stroke air-cooled			
Engine power, hp	12.0		14.0	
Crank case volume, cm ³	1.65		1.65	
Engine cylinder volume cm ³	418		456	
Power output controller	AVR		AVR	
Fuel heater	+		+	
Engine start	manual/electric		manual/electric	
Power factor, cosφ	1.0 (230V)		1.0 (230V)	
Housing	reinforced steel frame 32 mm			
Battery, Ah	30		30	
Output for ATS	-		-	
Dimensions (LxWxH), mm	730x495x630		730x495x630	
Net weight, kg	107		117	
Protection class	IP23M		IP23M	
Altitude (MAX), m	1000		1000	
Relative humidity	<95%		<95%	
Acceptable deviation of a current is 10%				

*Fuel consumption depends on many factors, such as load, fuel quality, season, altitude, technical condition of the generator.

LwA is sound power level. This indicator is measured in the immediate vicinity of the noise maker.

LpA is sound pressure level. This indicator is calculated as a function of the distance between the operator and the noise source. At a distance of 7 m: LpA (7) dB = (LwA - 25) dB

The optimum operating conditions are ambient temperature of 17°C – 25°C, barometric pressure of 0.1 MPa (760 mm Hg), and relative humidity of 50 – 60%. Under such ambient conditions, the generator can guarantee maximum performance in terms of the stated specifications. In case of deviations from the above ambient values, the performance of the generator can be different.

Please note that in order to preserve the lifespan of the generator, continuous loads should not exceed 80% of the rated power.

Model	KS 8100HDE-1/3 ATSR (EURO V) KS 8102HDE-1/3 ATSR (EURO II)		KS 9100HDE-1/3 ATSR (EURO V) KS 9102HDE-1/3 ATSR (EURO II)	
	Voltage, V	230	400	230
Max Power, kW	5.5	6.5	6.5	7.5
Nominal Power, kW	5.0	6.0	6.0	7.0
Frequency, Hz	50	50	50	
Current max, A	23.91	11.74	28.26	13.54
Outlets	1*32A, 1*16A (3p)		1*32A, 1*16A (3p)	
Fuel tank volume, l	11		11	
50% power working time, h*	6.9		6.1	
LED display	voltage, frequency, working hours			
Noise level Lpa (7m)/Lwa, dB	71/96		71/96	
Power output V/A	12/8.3		12/8.3	
Engine model	EURO II KS 480HD	EURO V KS 480HD-V	EURO II KS 520HD	EURO V KS 520HD-V
Engine type	diesel powered one-cylinder, four-stroke air-cooled			
Engine power, hp	14.0		18.0	
Crank case volume, cm ³	1.65		1.65	
Engine cylinder volume cm ³	456		498	
Power output controller	AVR		AVR	
Fuel heater	+		+	
Engine start	manual/electric		manual/electric	
Power factor, cosφ	1.0 (230V)	0.8 (400V)	1.0 (230V)	0.8 (400V)
Housing	reinforced steel frame 32 mm			
Battery, Ah	30		30	
Output for ATS	+		+	
Dimensions (LxWxH), mm	730x495x630		730x495x630	
Net weight, kg	117		122	
Protection class	IP23M	IP23M	IP23M	
Altitude (MAX), m	1000	1000	1000	
Relative humidity	<95%	<95%	<95%	
Acceptable deviation of a current is 10%				

*Fuel consumption depends on many factors, such as load, fuel quality, season, altitude, technical condition of the generator.

LwA is sound power level. This indicator is measured in the immediate vicinity of the noise maker.

LpA is sound pressure level. This indicator is calculated as a function of the distance between the operator and the noise source. At a distance of 7 m: LpA (7) dB = (LwA - 25) dB

The optimum operating conditions are ambient temperature of 17°C – 25°C, barometric pressure of 0.1 MPa (760 mm Hg), and relative humidity of 50 – 60%. Under such ambient conditions, the generator can guarantee maximum performance in terms of the stated specifications. In case of deviations from the above ambient values, the performance of the generator can be different.

Please note that in order to preserve the lifespan of the generator, continuous loads should not exceed 80% of the rated power.

Model	KS 8200HDES-1/3 ATSR		KS 9200HDES ATSR (EURO V)	KS 9200HDES-1/3 ATSR (EURO V)	
			KS 9202HDES ATSR (EURO II)	KS 9202HDES-1/3 ATSR (EURO II)	
Voltage, V	230	400	230	230	400
Max Power, kW	5.5	6.5	7.5	6.5	7.5
Nominal Power, kW	5.0	6.0	7.0	6.0	7.0
Frequency, Hz	50		50	50	
Current max, A	23.91	11.74	32.6	28.26	13.54
Outlets	1*32A, 1*16A (3p)		1x32A, 2x16A	1*32A, 1*16A (3p)	
Fuel tank volume, l	20		20	20	
50% power working time, h*	12.5		11.1	11.1	
LED display	voltage, frequency, working hours				
Noise level Lpa (7m)/Lwa, dB	69/94		69/94	69/94	
Power output V/A	12/8.3		12/8.3	12/8.3	
Engine model	EUROV KS 480HD-V		EURO II KS 520HD	EURO V KS 520HD-V	EURO II KS 520HD
Engine type	diesel powered one-cylinder, four-stroke air-cooled				
Engine power, hp	14.0		18.0	18.0	
Crank case volume, cm ³	1.65		1.65	1.65	
Engine cylinder volume cm ³	456		498	498	
Power output controller	AVR		AVR	AVR	
Fuel heater	+		+	+	
Engine start	electric		electric	electric	
Power factor, cosφ	1.0 (230V)	0.8 (400V)	1.0 (230V)	1.0 (230V)	0.8 (400V)
Housing	soundproof housing				
Battery, Ah	30		30	30	
Output for ATS	+		+	+	
Dimensions (LxWxH), mm	900x545x905		900x545x905	900x545x905	
Net weight, kg	163		165	168	
Protection class	IP23M		IP23M	IP23M	
Altitude (MAX), m	1000		1000	1000	
Relative humidity	<95%		<95%	<95%	
Acceptable deviation of a current is 10%					

*Fuel consumption depends on many factors, such as load, fuel quality, season, altitude, technical condition of the generator.

LwA is sound power level. This indicator is measured in the immediate vicinity of the noise maker.

LpA is sound pressure level. This indicator is calculated as a function of the distance between the operator and the noise source. At a distance of 7 m: LpA (7) dB = (LwA - 25) dB

The optimum operating conditions are ambient temperature of 17°C – 25°C, barometric pressure of 0.1 MPa (760 mm Hg), and relative humidity of 50 – 60%. Under such ambient conditions, the generator can guarantee maximum performance in terms of the stated specifications. In case of deviations from the above ambient values, the performance of the generator can be different.

Please note that in order to preserve the lifespan of the generator, continuous loads should not exceed 80% of the rated power.

Model	KS 9300DE ATSR (EURO V)		KS 9300DE-1/3 ATSR (EURO V)	
	KS 9302DE ATSR (EURO II)		KS 9302DE-1/3 ATSR (EURO II)	
Voltage, V	230		230	400
Max Power, kW	7.0		6.5	7.5
Nominal Power, kW	6.5		6.0	7.0
Frequency, Hz	50		50	
Current max, A	32.6		28.26	13.54
Outlets	1x32A, 2x16A		1*32A, 1*16A (3p)	
Fuel tank volume, l	20		20	
50% power working time, h*	11.1		11.1	
LED display	voltage, frequency, working hours			
Noise level Lpa (7m)/Lwa, dB	68/93		68/93	
Power output V/A	12/8.3		12/8.3	
Engine model	EURO II KS 520HD	EURO V KS 520HD-V	EURO II KS 520HD	EURO V KS 520HD-V
Engine type	diesel powered one-cylinder, four-stroke air-cooled			
Engine power, hp	18.0		18.0	
Crank case volume, cm ³	1.65		1.65	
Engine cylinder volume cm ³	498		498	
Power output controller	AVR		AVR	
Fuel heater	+		+	
Engine start	electric		electric	
Power factor, cosφ	1.0 (230V)		1.0 (230V)	0.8 (400V)
Housing	soundproof housing			
Battery, Ah	30		30	
Output for ATS	+		+	
Dimensions (LxWxH), mm	1080x550x800		1080x550x800	
Net weight, kg	165		168	
Protection class	IP23M		IP23M	
Altitude (MAX), m	1000		1000	
Relative humidity	<95%		<95%	
Acceptable deviation of a current is 10%				

*Fuel consumption depends on many factors, such as load, fuel quality, season, altitude, technical condition of the generator.

LwA is sound power level. This indicator is measured in the immediate vicinity of the noise maker.

LpA is sound pressure level. This indicator is calculated as a function of the distance between the operator and the noise source. At a distance of 7 m: $LpA(7) \text{ dB} = (LwA - 25) \text{ dB}$

The optimum operating conditions are ambient temperature of 17°C – 25°C, barometric pressure of 0.1 MPa (760 mm Hg), and relative humidity of 50 – 60%. Under such ambient conditions, the generator can guarantee maximum performance in terms of the stated specifications. In case of deviations from the above ambient values, the performance of the generator can be different.

Please note that in order to preserve the lifespan of the generator, continuous loads should not exceed 80% of the rated power.

When starting operating the generator, it's recommended to ground it. Before starting the unit, remember that the total power of consumers connected should not exceed the rated capacity of the generator.

TYPES OF CONSUMERS AND INRUSH CURRENT

Consumers (electrical devices connected to the generator) are divided into active and reactive ones. Active ones are those, which energy is converted into heat (heating devices).

Reactive are all consumers with electric motor. When you run the engine, starting currents occur briefly, the size of which depends on engine design and purpose. Please consider those starting currents when choosing a generator.

Most electric tools have starting current ratio 2-3. This means that when you turn such tools required generator power have 2-3 times more power load. The biggest factor of inrush current have such consumers as compressors, pumps, washing machines.



ATTENTION - DANGER!

To prevent electric shock and avoid damage to your electric devices and generator, simultaneous switching on of three and one phase circuit breaker is prohibited!

The generator is supplied without fuel. Before the operation please fill the fuel. Guidelines for filling are below. Generators are supplied without motor oil. The generator casing may contain residues of oil after tests conducted during production.

Before starting to use the generator, be sure to pour oil. Recommendations on oil and it's filling process are below. Follow maintenance recommendations during the first month or twenty hours (whichever occurs first) contained in the "Maintenance" section.

CHECK THE FUEL LEVEL

1. Remove the fuel tank cap and check the fuel level.
2. Fill fuel to the level of the fuel filter and make sure there is no air in the fuel system.
3. Screw the fuel tank cap back tightly.

CHECK THE OIL LEVEL

1. Unscrew the oil level gage and clean it with clean cloth.
2. Put the oil gage back without screwing it.
3. Take the oil level gage out and check the oil level according to the mark on a gage.
4. Add oil if it's level is below the mark on a gage.
5. Screw the oil gage back.

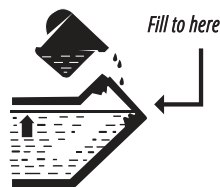

For commissioning models with elektrostart please charge the battery. Please use additional battery charger (not included) to charge the battery or let the generator work at least one hour at 50% load at the first start.



IMPORTANT!

Diesel fuel type should correspond the operating season.

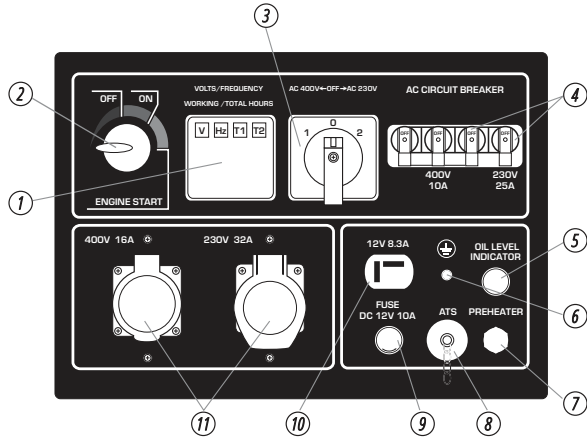

1. LED-display:
V - voltage
Hz - frequency
T1 - current time (since the last start)
T2 - total time (since the commissioning)
2. Engine start
3. VTS system single-/three-phase switch
(position 1 - 400V, position 0 (OFF) - disabled,
position 2 - 230V)
4. Circuit breaker
5. Oil level indicator
6. Grounding
7. Fuel heater
8. Output for ATS
(except for models KS 6100HDE, KS 6102HDE,
KS 8100HDE, KS 8102HDE)
9. 12V DC fuse
10. 12V DC outlet
11. Sockets

Before starting the engine, make sure that the rated power of power consumers matches with the power of generator. Do not exceed the nominal power of the generator. **Do not connect the device before starting the engine!**

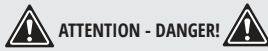

ATTENTION - DANGER!

Do not change the configuration of the amount of fuel or speed controllers (this adjustment was made before the sale). Otherwise, there will be possible changes in the engine work or breakage. Any changes to the design of the generator will void the warranty service!

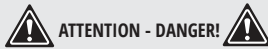

ATTENTION - DANGER!

Do not let the generator work more than 30 minutes in range from nominal to maximum.

This material is for informational purposes only and is not an instruction how to install or connect equipment to the network. In practice, there are different options for supplying electricity and different rules for its connection. The decision on how to properly connect the equipment in each individual case must be made by a certified electrician who performs the installation and electrical connection of the equipment. The manufacturer is not responsible for improper connection of equipment, and is not responsible for possible material and physical damage that may occur as a result of improper installation, connection or operation of equipment.

IN THE FIRST 20 OPERATING HOURS OF THE GENERATOR, THE FOLLOWING REQUIREMENTS SHOULD BE MET:

1. During commissioning, do not connect power consumers, the power of which exceeds 50% of the nominal (operating) power of the device.
2. After the first 20 operating hours, be sure to change the oil. It is better to drain oil while the engine is still hot after operation to ensure quick and complete oil draining.
3. Check and clean the air filter and fuel filter.

MANUAL START

Do not connect any devices before you start the engine!

1. Connect the positive terminal of the battery.
2. Turn the motor safety switch (Fig. 1) to ON position.
3. Pull the starter handle until you feel resistance.
4. Remove the rubber plug on the top cover of the generator, which is under decompressor lever (fig. 2), push the decompressor at the top of cylinder head to reduce pressure in the cylinder and relief extension.
5. Vigorously pull starter handle and start the engine.
6. Do not let a sharp return to starter motor. To avoid starter damage, return it to the original position carefully.
7. After three minutes of the generator work, switch machine protection (Emergency switch) in the upper position ON.



Fig.1



Fig.2

ELECTRIC START

1. Do not connect any devices before you start the engine!
2. Connect the positive terminal of the battery.
3. Turn the motor safety switch (Fig. 1) to ON position.
4. Set the key to ON position.
5. Turn the key clockwise to START position.
6. After the engine launch, release the key, and it will automatically return to ON position.
7. If the engine doesn't start after keeping the key in START position for 10 seconds, wait 15 seconds before trying start again. The battery can discharge after continuous work of launch engine system. Leave the key in ON the position during work.
8. After three minutes of the generator work, switch machine protection (Emergency switch) in the upper position ON.



IMPORTANT!



If engine does not start after three or four attempts, it may mean that the fuel system has some air inside. Remove the air from the fuel system (drain the diesel fuel, with the fuel there will be excess of air).



ATTENTION - DANGER!



Do not let the simultaneous connection of two or more devices. Start of many devices requires large power capacity

Devices are to be connected in turns, according to its maximum allowed power. Do not connect the consumers in first 1-2 minutes after the generator start. Do not stop the generator, if there are any devices connected. This may result to generator breakdown.

Before turning the generator on, verify that the connected devices are in working order. If the connected device suddenly stops running – turn the power off by means of an emergency switch, disconnect the device and check it.



IMPORTANT!



DISCONNECT ALL DEVICES BEFORE STOPPING THE GENERATOR! Do not stop the generator with the devices turned on. This may disable the generator or devices connected to it!

STARTING WITH ELECTRIC STARTER IN THE COLD SEASON

- When the air temperature is lower than +5°C it is necessary to use the «Warmingup» function when starting.
- Turn the ignition key to ON position and push the heating button. Hold it and turn the ignition key to START position.



IMPORTANT!



Do not hold the ignition key in “Warming-up” position more than 10 seconds, it may cause the failure of incandescent candles

DURING GENERATOR OPERATION:

- You can use the generator if the voltmeter shows $230 \pm 10\%$ for a single-phase generator and $400V \pm 10\%$ for a three-phase generator (50 Hz).
- Watch the voltage meter and in case of excessive indices values, stop the generator operation.
- Connection to continuous voltage socket is used for accumulator recharge only. Upon accumulator unit recharge, it is mandatory to verify the polarity correctness (+ to +, - to -).
- Charging device wires have to be at first connected to the accumulator unit and only then – to the generator itself. All “generator to network” connections are to be carried out by a certified electrician. Any mistakes may result in serious equipment damage.
- It is forbidden to use 12V voltage simultaneously with 230V (400V for threephase generators).

STOPPING THE ENGINE

1. Set the circuit breaker (safety switch) on the generator control panel to the down position (OFF), stop all power consuming devices connected to the generator.
2. Let the generator run at no load for 3 minutes for alternator to be cooled.
3. Turn the key to OFF position.
4. For all types of diesel generators there is an emergency stop emergency switch engine. Use it in case of emergency only.

CONNECTING DEVICES

Do not let the generator work more than 30 minutes in range from nominal to maximum.

After starting the engine, make sure the voltmeter readings correspond to the nominal (at 50 Hz 230V + -10% for single-phase units and 400 + -10% for threephase).

STARTING THE GENERATOR USING THE ATS UNIT

When starting the generator in automatic or manual mode using the ATS unit (automatic transfer switch), the start key on the generator control panel must be in the “OFF” position.

FOR THREE-PHASE DIESEL GENERATOR

Three-phase diesel generator load must be distributed on all three phases, and the load on all phases must be balanced. The load on 1 phase should not exceed 1/3 of the total generator capacity. Maximum permissible imbalance is 20%.

Only 1 or 2 phase load leads to the generator breakage. The total load and total current on all three phases should not exceed nominal load and current of the generator.



IMPORTANT!



Failure to follow these instructions may lead to damage of the rotor and stator windings, the AVR unit.

MODELS WITH VTS SYSTEM VTS

Models named "1/3" are equipped with a VTS phase switching system. These models can operate in single-phase (230V) and three-phase (400V) almost without loss of power.



IMPORTANT!



Switching modes is only allowed when the load is completely switched off.



ATTENTION - DANGER!



An overload may lead to automatic activation of generator protection machine. Reduce the load. Reconnect the generator no earlier than 5 minutes after switching off.

TECHNICAL MAINTENANCE WORKS

10

Works, specified in "Technical maintenance" section, are to be regularly performed. If the generator user has no possibility to perform regular maintenance independently, it is necessary to address the official service center to register an order for such works performance.



IMPORTANT!



In case of any damages, occurred due to non-performance of regular maintenance works, the manufacturer bears no responsibility for such damages.

SUCH DAMAGES ARE ALSO:

- Damages occurred as a result of using non original spare parts;
- Corrosion damages and other results of improper equipment storage;
- Damages occurs as a result of maintenance performance by inexperienced and unauthorized specialists.

MANUAL COMPLIANCE

Technical maintenance, operation and Könnér & Söhnen® generator storage are to be performed according to this manual recommendations. Manufacturer bears no responsibility for damages and losses, caused by incompliance to safety requirements and technical maintenance rules.

FIRST OF ALL THIS APPLIES TO:

- use of lubricants, gasoline and motor oils, forbidden by the manufacturer;
- device technical alterations;
- equipment operations against its intended use;
- indirect damages, caused by operating faulty equipment;

This manual compliance! You can find a list of service center addresses on the website of exclusive importer:
www.koenner-soehnen.com

TECHNICAL MAINTENANCE WORKS

Node	Service type	Every start	Commissioning (first 20 hours)	Each 3 months or after 50 working hrs	Each 6 months or after 100 working hrs
Motor oil	Check the level	✓			
	Replace		✓	✓	
Air filter	Check/Clean out		✓	✓	
	Replace				✓
Oil filter	Clean out		✓	✓	
Fuel tank	Check the level	✓			
	Check/Clean out		✓		✓
Fuel filter	Check/Clean out		✓	✓	
	Replace				✓

RECOMMENDED OILS

11

Motor oil has a serious impact on performance characteristics and is a major attribute, defining its service life. Use oils designed for four-stroke cycle vehicle engines SAE 10W-30, SAE 10W-40, since such oils contain cleaning additives, which comply or even exceed SE standards according to API classification (or equivalent). Motor oils with other viscosity levels, may be used only if the average air temperature in your region does not exceed the limits of the temperature range, specified in the table. Oil viscosity according to SAE standards or service category, are specified on the API capacity sticker.

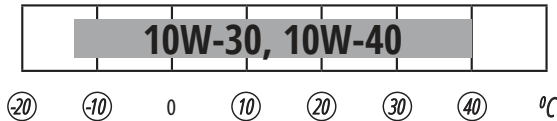

ENGINE OIL REPLACEMENT OR ADDING

Upon oil level decrease it is necessary to add the required quantity in order to provide the correct generator operation. It is necessary to check the oil levels according to technical maintenance schedule. When changing the oil, remove the oil filter, flush it with gasoline and install it back.

TO DRAIN THE OIL:

1. Place a drain oil holding tank under the engine.
2. Turn the drain cap, located under the oil-depth gage cap in the engine, by means of a 10mm hexagon spanner.
3. Wait till the oil drains.
4. Put the drain cap back and tighten it well.

OIL FILLING:

1. Make sure that the generator is set on flat level surface.
2. Unscrew the oil gage cap on the engine.
3. By means of a funnel, pour the advanced purification engine oil to the crankcase. The funnel is not included. Oil level after filling has to be close to the upper part of oil filler.

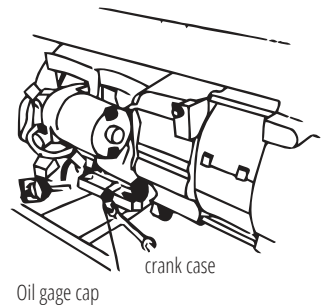
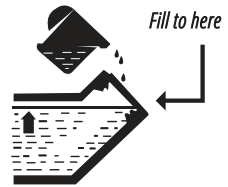

It is necessary to check the air filter from time to time and clean any contaminations. Regular air filter maintenance is necessary to maintain sufficient carburetor air inflow. The air filter should be cleaned more often when using generator in dusty conditions.

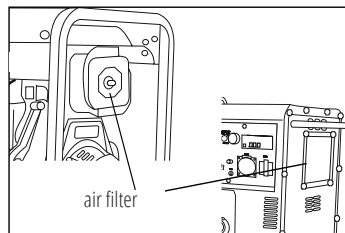

ATTENTION - DANGER!

Never run the engine with the air filter removed or without the filter. Otherwise dirt and dust lead to rapid breakage of engine parts. Failure in this case will not be repaired.



IMPORTANT!



Air filter replacement is to be performed each 100 hours of the generator operation (every 10 hours in unusually dusty conditions).

FUEL FILTER TECHNICAL MAINTENANCE

13

There are two kinds of fuel filters in Könnér & Söhnen® diesel generators. They prevent the ingress of contaminants from diesel fuel to the engine.

COARSE CLEANING FUEL FILTER

Remove the filter after the possible hard particles hit every 500 operating hours. Never use water for purification the filter.

1. Remove the fuel cap.
2. Remove the fuel filter.
3. Use diesel fuel to clean the filter.
4. Put the filter back to the fuel tank.

THE FUEL FILTER IN THE FUEL SUPPLY PIPELINE

This filter has to be replaced every 100 operating hours. It's located under the fuel tank on the fuel hose through which fuel enters the engine from the tank. To replace it:

1. Loosen the metal hose clamps, located next to the fuel valve to drain the fuel.
2. Drain the fuel to some special volume.
3. Loosen metal staples on both sides of the fuel filter.
4. Remove the filter.
5. Install new filter, paying attention to the arrow shown. The filter should be installed in the fuel passage direction.
6. Tighten the bracket on the fuel hose.



fuel filter



ATTENTION - DANGER!

Keep an eye on the position of the fuel filter, it should be located to the maximum upright.

ACCUMULATOR MAINTENANCE

14

In **Könnér & Söhnen®** models with electric start you should periodically perform battery voltage checks. The generator battery has a voltage of 12V and if the voltage is lower, you should perform battery charging with the help of an external charger.

To avoid discharging the battery, it is recommended to run the generator at least once a month for 30 minutes. If the generator is not used for a long time, please disconnect the battery from the terminals. The battery that comes with the generator does not require additional maintenance and filling of electrolyte.

The generator battery is not subject to service. If the generator is not used for a long time, the battery may fail. To prolong battery life it is recommended to do battery charging with an external device (not included) every three months.

Battery warranted - three months from the date of purchase of the generator.

GENERATOR STORAGE

15

Storage room has to be dry and free from dust deposits. Storage room also has to be locked away from children.



IMPORTANT!



Warning! Generator is to remain ready for operation at all times. Therefore in case of device malfunctions, they are to be repaired before dismantling the generator for storage.

LONG-TERM STORAGE

If you do not plan to use the generator for a long time, we recommend:

- Drain the fuel from the tank.
- Drain the oil from the engine.
- Pull the manual starter until you feel light resistance so that the intake and exhaust valves are closed.
- Remove the negative terminal of the battery for the electric start models.
- Clean generator from dirt and dust.

When starting the generator after long storage, follow all procedures in reverse order.



IMPORTANT!



Pay attention to the fact that upon failed attempts to launch the generator by means of an electric start, the accumulator units may turn out de-energized, therefore prior to operation start it may be necessary to perform full accumulator unit charging.

BATTERY AND GENERATOR DISPOSAL

16

To prevent environment damage generator and battery should be separated from ordinary waste. Please recycle them in the safest way, passing it to special place for disposal.

Typical failures	Possible reason	Вариант усунення
Engine does not start	Engine starting switch set to OFF position	Set the engine starting switch to ON
	No fuel	Add fuel
	Low-quality or dirty fuel is in engine	Change the fuel
Low engine power / heavy starting	Dirt in fuel tank	Clean the fuel tank
	Air filter is dirty	Change the air filter
	Water or air in the fuel line	Pump the fuel line
Engine is overheated	Cooling fins are dirty	Clean the cooling fins
	Air filter is dirty	Change the air filter
No voltage while engine is working	Circuit breaker is active	Turn on the circuit breaker
	Connected cables are corrupted	Check the cables; if using extension cord, change it
	Plugged device failure	Try to connect other devices
Connected devices are not working while generator is running	Generator is overloaded	Unplug some devices to reduce load
	Short circuit occurred in one of the devices connected	Unplug that device to restore the stability of a system
	Air filter is dirty	Change the air filter
	Repetitions of an engine are lower than nominal	Contact the service center



ATTENTION - DANGER!



To prevent electric shock and avoid damage to your electric devices and generator, simultaneous switching on of three and one phase circuit breaker is prohibited!

Device	Average power usage, W
Iron	500-1100
Air hair dryer	450-1200
Coffee machine	800-1500
Electric cooking stove	800-1800
Toaster	600-1500
Air heater	1000-2000
Vacuum cleaner	400-1000
Radio	50-250
BBQ Grill electric device	1200-2300
Oven	1000-2000
Refrigerator	100-150
TV set	100-400
Hammer drill	600-1400
Drill	400-800
Freezer	100-400
Grinding machine	300-1100
Circular saw	750-1600
Angle grinder	650-2200
Electro jigsaw	250-700
Electro planer	400-1000
Compressor	750-3000
Water pump	750-3900
Electric sawing machine	1800-4000
Electric lawn	750-3000
Electric powered engines	550-5000
Electric fan	750-1700
High pressure machine	2000-4000
Air conditioner	1000-5000

The international manufacturer warranty is 1 year. The warranty period starts from the date of purchase. In cases when warranty period is longer than 1 year according to local legislation please contact your local dealer. The Seller which sells the product is responsible for granting the warranty. Please contact the Seller for warranty. Within the warranty period, if the product fails because of defects in the production process, it will be exchanged on the same product or repaired.

The warranty card should be kept throughout the warranty period. In case of warranty card loss, a second one will not be provided. The customer must provide the warranty card and buyer's check during request for repair or exchange. Otherwise, the warranty service will not be provided. The warranty card, attached to the product during sale, should be correctly and fully completed by the retailer and customer, signed and stamped. In other cases, warranty is not considered as valid.

Provide clean product to the service center. Parts, that must be replaced, are the property of the service center.

WARRANTY EXCLUSIONS:

- If the user has failed to comply with the instructions in this manual.
- If the product features damaged or missing identification stickers or labels, serial numbers, etc.
- If product malfunction was due to improper transportation, storage and maintenance.
- In case of mechanical damages (cracks, chips, impact and fall marks, deformation of housing, power cord, plug or any other components), including those resulting from the freezing of water (ice formation), provided there are foreign objects inside the unit.
- If the product has been improperly installed and connected to the mains supply or misused.
- If the claimed malfunction cannot be diagnosed or demonstrated.
- If proper operation of the product can be restored following cleaning from dust and dirt, appropriate adjustment, maintenance, oil change, etc.
- If the product is used for business related purposes.
- If faults are detected, which have been caused by product overload. Signs of overload are molten or discolored parts as a result of high temperatures, damaged cylinder or piston surfaces, degraded piston rings or connecting rod bushes.
- The warranty does not cover the failure of the product automatic voltage regulator due to careless handling or mishandling.
- If faults are detected, which have been caused by instability of the user's power grid.
- If there are faults caused by contamination or fouling such as contamination of the fuel, oil or cooling system.
- If electrical cables or plugs show signs of mechanical or thermal damage.
- In the event of foreign liquids and objects, metal chips, etc. inside the product.
- If the malfunction is caused by the use of non-original spare parts and materials, oils, etc.
- If there are two or more faulty units that are not interconnected.
- If the damage was caused by natural factors such as dirt, dust, humidity, high or low temperature, natural disasters.
- In case of simultaneous failure of the rotor and stator.
- For wear parts and accessories (spark plugs, nozzles, pulleys, filter and safety elements, batteries, detachables, belts, rubber seals, clutch springs, axles, hand starters, grease, mountings, working surfaces, hoses, chains, and tires).
- To preventive maintenance (cleaning, greasing, washing), installation and adjustment.
- If the product was tampered with, independently repaired or modified.
- In case of malfunctions resulting from normal wear and tear as a result of long-term use (end of life).
- If product operation was not stopped and continued after detecting a malfunction.
- Batteries supplied with equipment are covered by a warranty of three months.
- When using low-grade or inappropriate fuel.



EC Declaration of Conformity

Nr. 119

The following products have been tested by us with the listed standards and found in compliance with the European Community Machinery Directive 2006/42/EC, Electromagnetic compatibility Directive (EMC) 2014/30/EC, Noise Directive 2000/14/EC.

Manufacturer: DIMAX INTERNATIONAL GmbH
Address: Flinger Broich 203, 40235 Duesseldorf, Germany

Product: Diesel generators "Könner & Söhnen"

Type / Model: KS 6100HDE, KS 6102HDE, KS 8100HDE, KS 8102HDE,
KS 8100HDE-1/3 ATSR, KS 8102HDE-1/3 ATSR, KS 9100HDE-1/3 ATSR,
KS 9102HDE-1/3 ATSR, KS 8200HDES-1/3 ATSR, KS 9200HDES ATSR
KS 9202HDES ATSR, KS 9200HDES-1/3 ATSR, KS 9202HDES-1/3 ATSR,
KS 9300DE ATSR, KS 9302DE ATSR, KS 9300DE-1/3 ATSR,
KS 9302DE-1/3 ATSR.

The statement is based on a single evaluation of above mentioned products. It does not imply an assessment of the whole production and does not permit the use of the test lab. logo. The manufacturer should ensure that all product in series production are in conformity with the product sample detailed in this report. The applicant should hold the whole technical report at disposal of the competent all the right.

Applied EC Directives: 2006/42/EC Machinery Directive
2014/30/EC Electromagnetic compatibility Directive (EMC)
2000/14/EC Noise Directive
(EU) 2016/1628 Non-Road mobile machinery emissions

Applied Standards: EN ISO 8528-13:2016,
IEC 60034-1:2010,
EN55012:2007+A1:2009.

Diesel engines KS 440HD-V, KS480HD-V, KS 520HD-V correspond to European Emission Standard Euro V (STAGE V). This is confirmed by EU TYPE-APPROVAL CERTIFICATE issued by department of transport of Madrid, Spain. Technical service responsible for carrying out the test -IDIADA.
Date of test reports 12/08/2019



Issued Date: 2022-03-06
Place of issue: Duesseldorf
General Director: Fomin P. *P. Fomin*

DIMAX
International
GmbH
Steuer-Nr.: 103 5722 2493
USt-Id-Nr.: DE29617274

We DIMAX INTERNATIONAL GmbH hereby declare that specified above conforms covering European Parliament and Council Directives, 2006/42/EC of 17 May 2006 Machinery Directive, Electromagnetic compatibility Directive (EMC) 2014/30/EC of 26 February 2014, Noise Directive 2000/14/EC of 8 May 2000. The CE mark above can be used under the responsibility of manufacturer. After completion of an EC declaration of Conformity and compliance with all relevant EC directives.

CONTACTS

Deutschland:

DIMAX International GmbH
Flinger Broich 203 -FortunaPark-
40235 Düsseldorf, Deutschland
koenner-soehnen.com

Ihre Bestellungen

orders@dimaxgroup.de

Kundendienst, technische Fragen und Unterstützung

support@dimaxgroup.de

Garantie, Reparatur und Service

service@dimaxgroup.de

Sonstiges

info@dimaxgroup.de

Polska:

DIMAX International
Poland Sp.z o.o.
Polen, Warczawska,
306B 05-082 Stare Babice,
koenner-soehnen.com
info.pl@dimaxgroup.de

Україна:

ТОВ «Техно Трейд КС»,
вул. Електротехнічна 47, 02222,
м. Київ, Україна
koenner-soehnen.com
sales@ks-power.com.ua